

φ 5 mm

**S1**

**S11**

A	B	C (mm)		D
1	S174-008	1296	346	2/2
2	S174-103	1268	350	1/2
3	S174-105	1268	331	1/2
4	S174-202	800	350	1/2
5	S174-203	800	350	1/2
6	S174-305	424	321	2/2
7	S174-306	424	321	2/2
8	S174-307	327	321	1/2
9	S174-551	233	200	1/2
10	S174-552	420	260	1/2
11	S174-704	184	350	1/2
12	S174-705	884	350	1/2
13	S174-7705	898	446	2/2
14	S174-7706	198	446	2/2
15	S174-7714	175	200	2/2
16	S174-9913	1278	437	2/2
17	S174-9914	1278	340	2/2
18	qc11/1			1/2

**90 min**

cm

6x 	6x 	2x 	16x 	6x 	9x 	20x 	4x 	4x 	5x 	26x 	12x 	4x 
9x 	10x 	22x 	4x 	14x 	22x 	1x 	1x 	1x 				

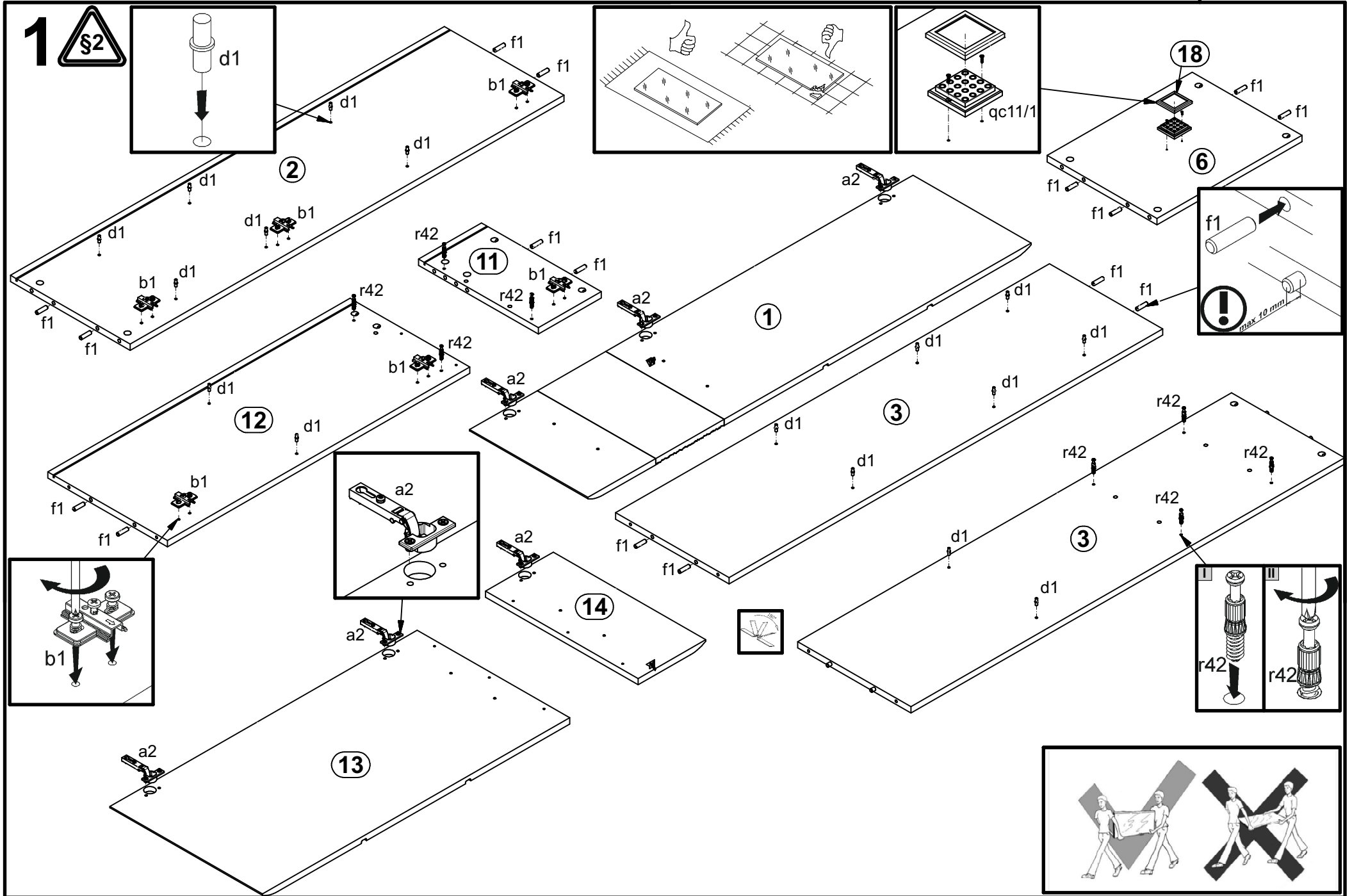

2

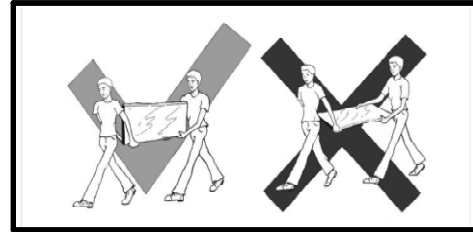
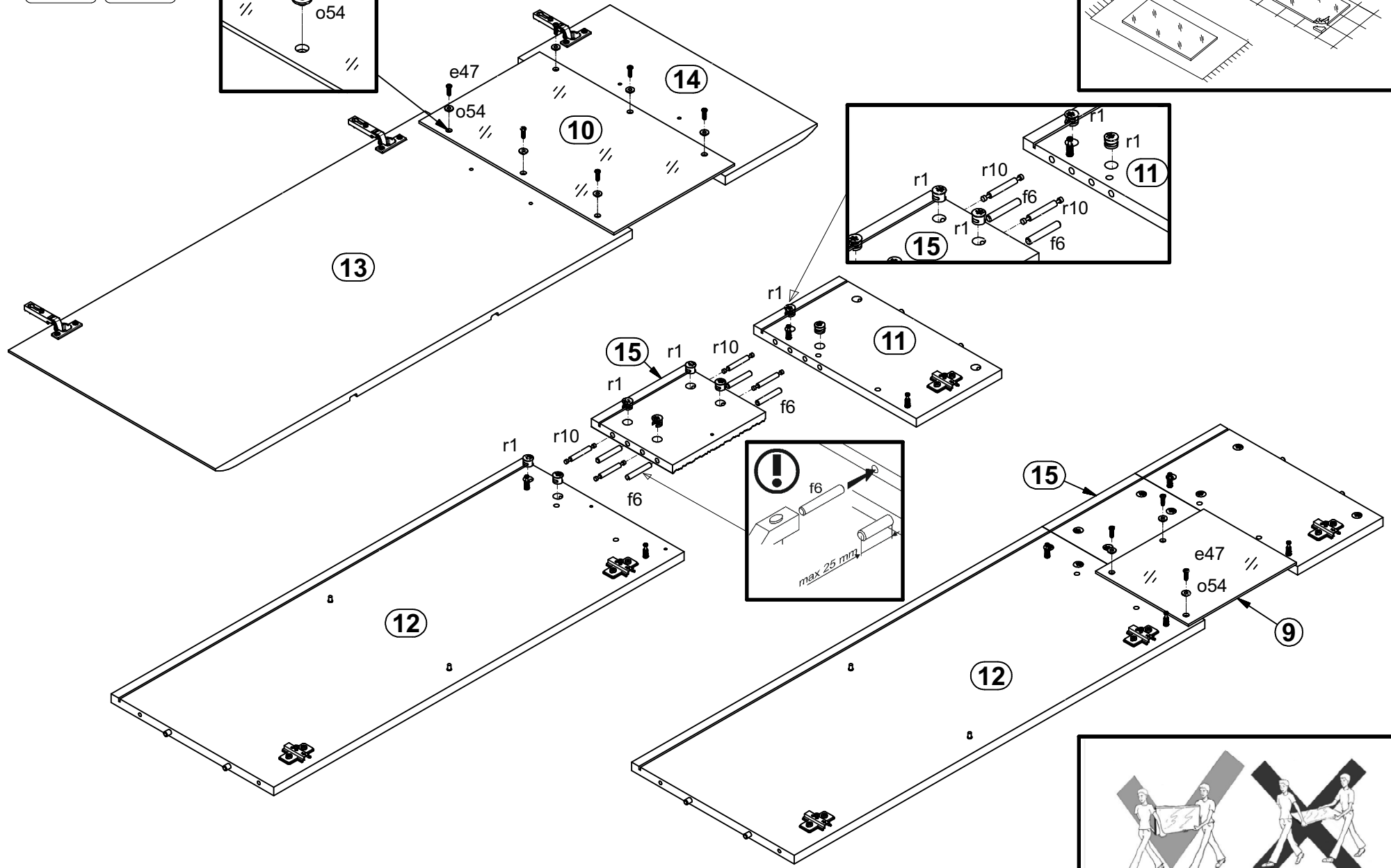
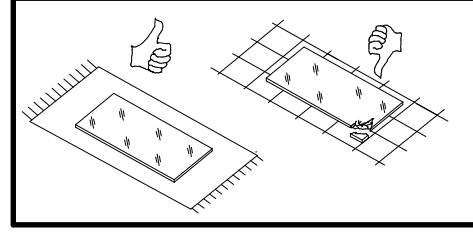
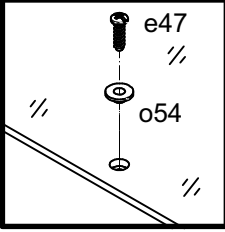

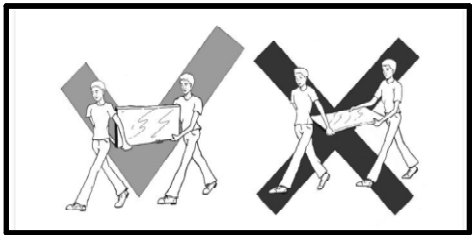
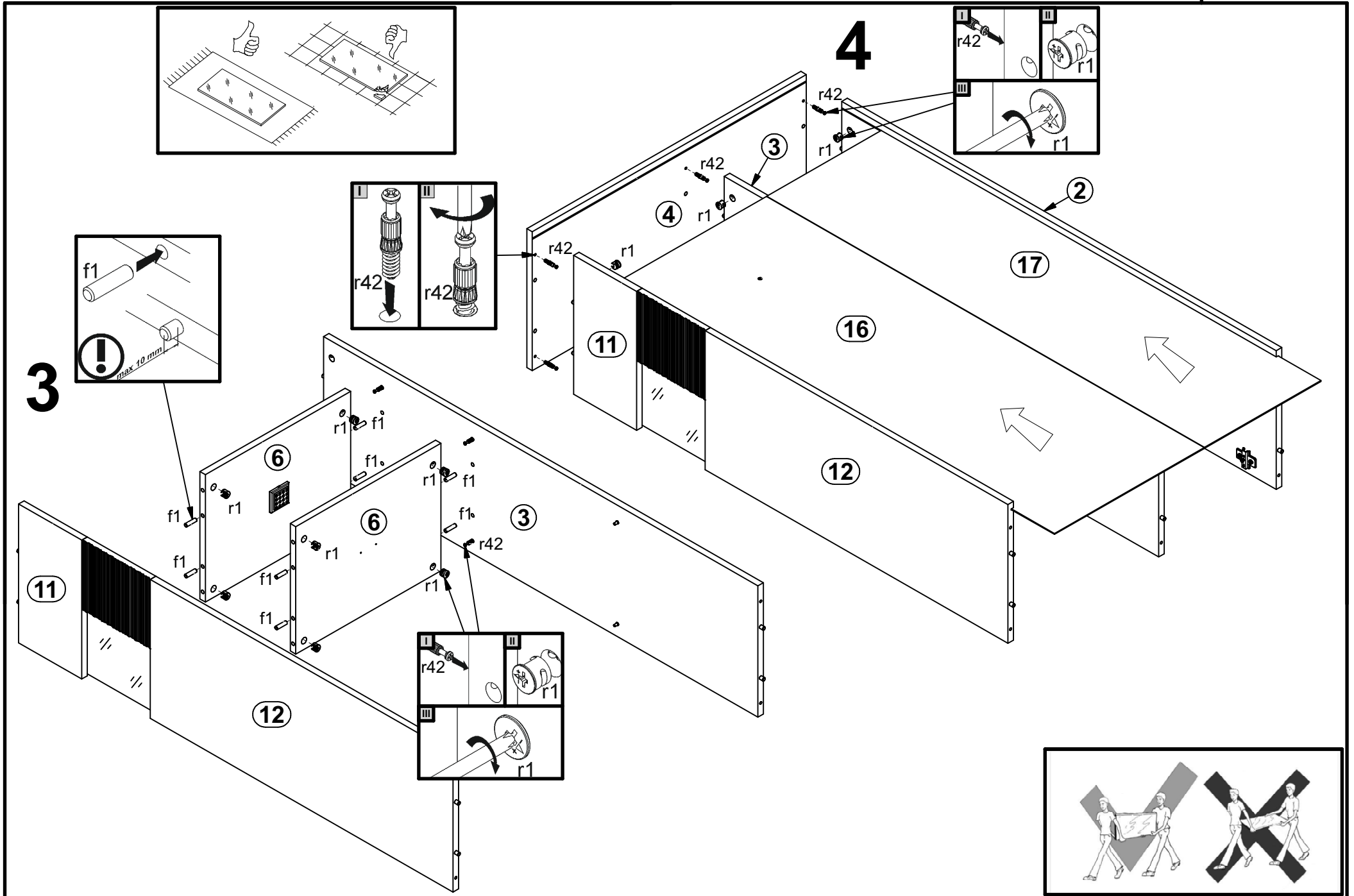



6

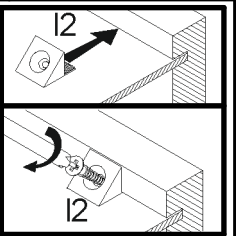
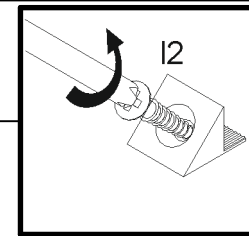
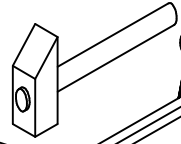
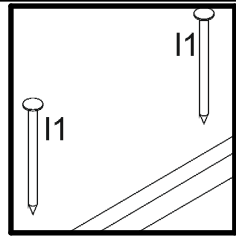
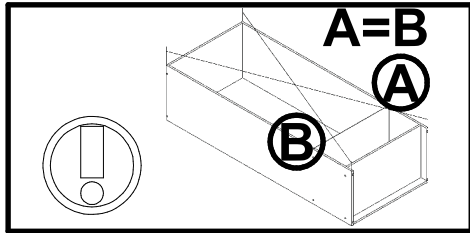

5

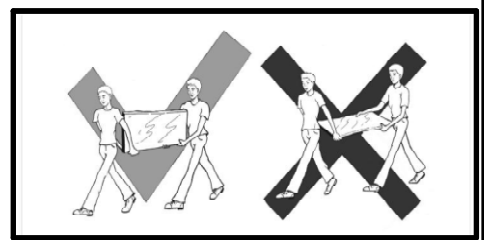
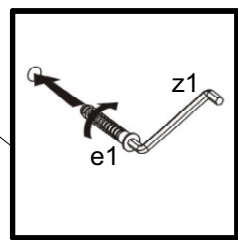
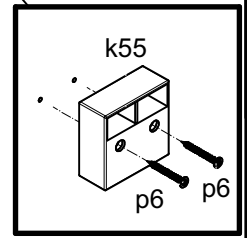
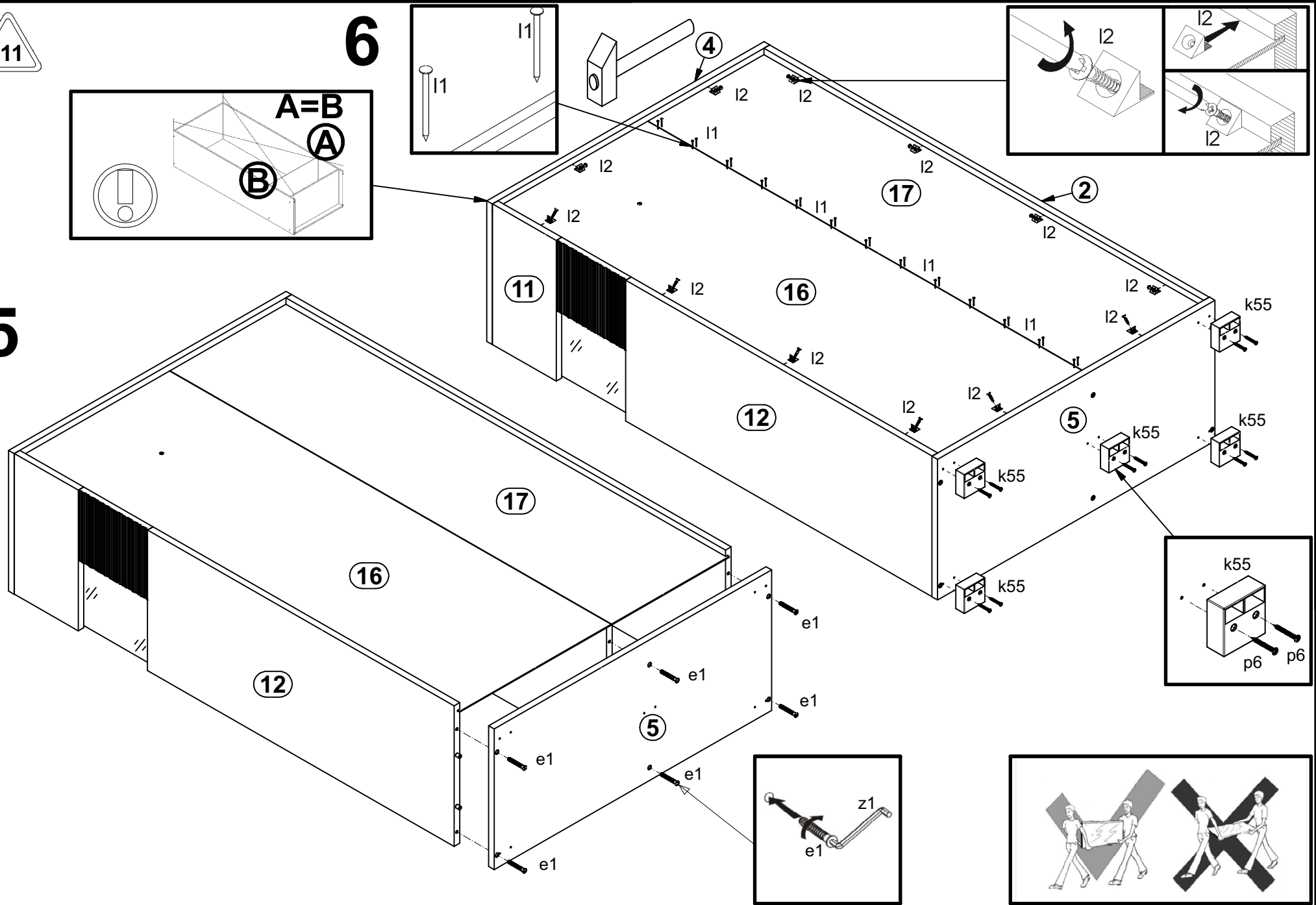

7

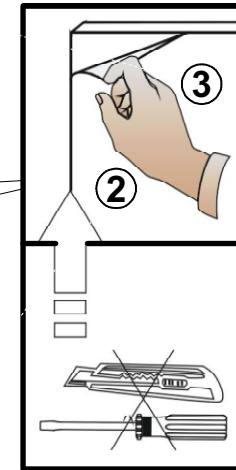
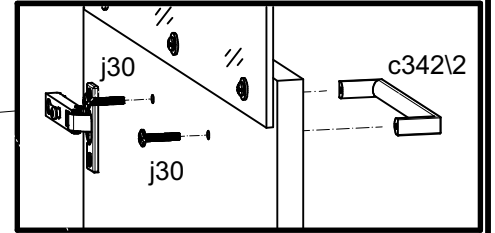
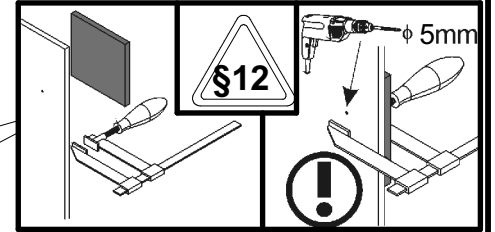
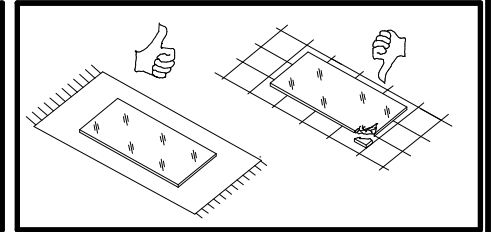
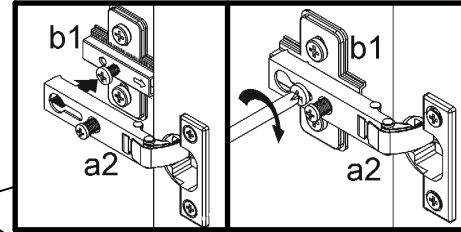
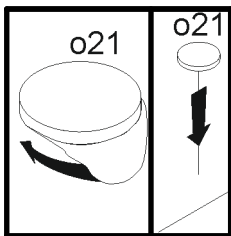
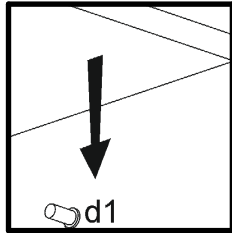
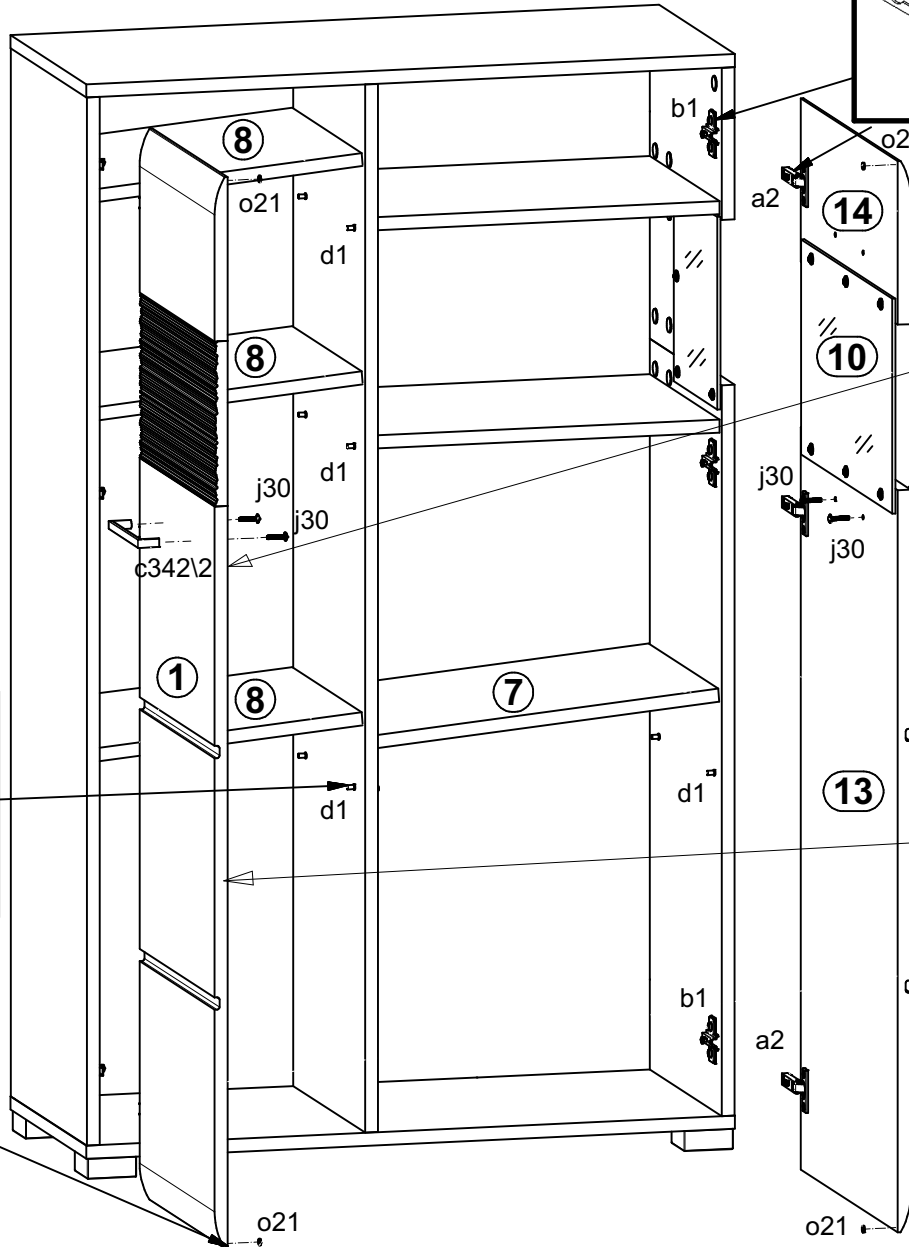

8

